

4831, solder terminal, insulated, 3-pole, Audio Plug/Sockets, 2.5 mm



Description

- Solder terminal :
for cable mounting
- Audio entrances and exits
- Data and Signal transfer
- Audio Plug: 3-pole , insulated , angled

References

Alternative: Housing shielded [4831.1300](#)

Technical Data

Diameter	2.5 mm
Number of Poles	3-pole
Ratings DC	0.5 A / 30 VDC
Ratings AC	0.5 A / 30 VAC
Dielectric Strength	500VDC
Insulation Resistance	> 100 MΩ @ 500VDC

Allowable Operation Temp.	-20 °C to 70 °C
Terminal	solder terminal nickel-plated
Housings	insulated
Style	angled
Lifetime	5000 Insertions

Dimensions

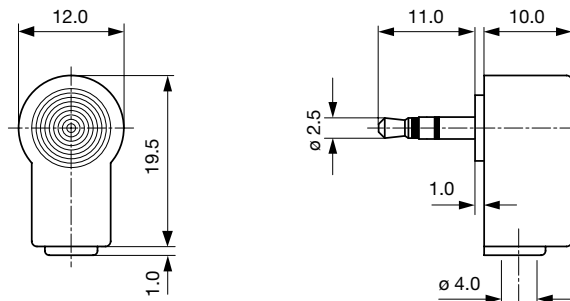

Cable diameter max. 4.0 mm

All Variants

Product group	Diameter [mm]	Number of Poles	Terminal	Order Number
Audio Plug/Sockets	2.5	3-pole	solder terminal	4831.1320

Availability for all products can be searched real-time: <http://www.schurter.com/Stock-Check/Stock-Check-SCHURTER>

Packaging unit 100 Pcs

Mating Outlets/Connectors

Category / Description

[Audio Plug/Sockets Overview complete](#)



4831, solder terminal, screened, 3-pole, Audio Plug/Sockets, 2.5 mm	4831.2300
4831, PCB terminals, screened, 3-pole, Audio Plug/Sockets, 2.5 mm	4831.2320
4831, PCB terminals, insulated, 3-pole, Audio Plug/Sockets, 2.5 mm	4831.2330
4831, solder terminal, insulated, 3-pole, Audio Plug/Sockets, 2.5 mm	4831.3300

[Audio Plug/Sockets further types to 4831.1320](#)